

# ECO-PAC™

## Three Phase Rectifier Bridge

### with Fast Recovery Epitaxial Diodes (FRED)

$I_{dAV} = 74 \text{ A}$   
 $V_{RRM} = 1200 \text{ V}$   
 $t_{rr} = 40 \text{ ns}$

$V_{RSM}$ V	$V_{RRM}$ V	Type
1200	1200	VUE 75-12NO7

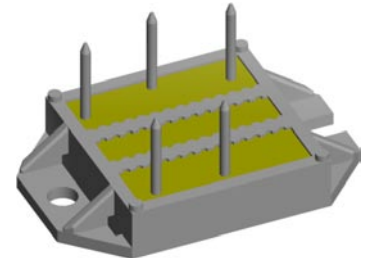
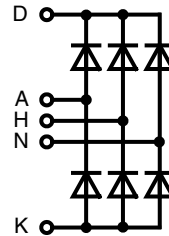

Symbol	Conditions	Maximum Ratings	
$I_{dAV}$ ①	$T_C = 85^\circ\text{C}$ , module	74	A
$I_{dAVM}$		90	A
$I_{FSM}$	$T_{VJ} = 45^\circ\text{C}$ ; $t = 10 \text{ ms}$ (50 Hz)	200	A
	$V_R = 0$ ; $t = 8.3 \text{ ms}$ (60 Hz)	220	A
	$T_{VJ} = 125^\circ\text{C}$ ; $t = 10 \text{ ms}$ (50 Hz)	170	A
	$V_R = 0$ ; $t = 8.3 \text{ ms}$ (60 Hz)	190	A
$I^2t$	$T_{VJ} = 45^\circ\text{C}$ ; $t = 10 \text{ ms}$ (50 Hz)	200	A <sup>2</sup> s
	$V_R = 0$ ; $t = 8.3 \text{ ms}$ (60 Hz)	205	A <sup>2</sup> s
	$T_{VJ} = 125^\circ\text{C}$ ; $t = 10 \text{ ms}$ (50 Hz)	145	A <sup>2</sup> s
	$V_R = 0$ ; $t = 8.3 \text{ ms}$ (60 Hz)	150	A <sup>2</sup> s
$T_{VJ}$		-40...+150	°C
$T_{VJM}$		150	°C
$T_{stg}$		-40...+125	°C
$V_{ISOL}$	50/60 Hz, RMS $t = 1 \text{ min}$	3000	V~
	$I_{ISOL} \leq 1 \text{ mA}$ $t = 1 \text{ s}$	3600	V~
$M_d$	Mounting torque (M4)	1.5 - 2	Nm
Weight	typ.	19	g

#### Features

- Package with DCB ceramic base plate in low profile
- Isolation voltage 3000 V~
- Planar passivated chips
- Low forward voltage drop
- Leads suitable for PC board soldering

#### Applications

- Supplies for DC power equipment
- Input and output rectifiers for high frequency
- Battery DC power supplies
- Field supply for DC motors

#### Advantages

- Space and weight savings
- Improved temperature and power cycling capability
- Small and light weight
- Low noise switching

Symbol	Conditions	Characteristic Values		
		(T <sub>VJ</sub> = 25°C, unless otherwise specified)		
		typ.	max.	
$I_R$	$V_R = V_{RRM}$ $T_{VJ} = 25^\circ\text{C}$		0.25	mA
	$V_R = V_{RRM}$ $T_{VJ} = T_{VJM}$		1.0	mA
$V_F$	$I_F = 30 \text{ A}$ $T_{VJ} = 25^\circ\text{C}$		2.71	V
$V_{T0}$	For power-loss calculations only		1.31	V
$r_t$			15	mΩ
$R_{thJC}$	per diode; DC current		0.9	K/W
	per diode; DC current, typ.		0.3	K/W
$I_{RM}$	$I_F = 50 \text{ A}$ ; $-di_F/dt = 100 \text{ A}/\mu\text{s}$ $V_R = 100 \text{ V}$ ; $L = 0.05 \text{ mH}$ ; $T_{VJ} = 100^\circ\text{C}$	6	11.4	A
$t_{rr}$	$I_F = 1 \text{ A}$ ; $-di/dt = 200 \text{ A}/\mu\text{s}$ ; $V_R = 30 \text{ V}$ ; $T_{VJ} = 25^\circ\text{C}$	40	tbid	ns
$d_s$	Creeping distance on surface	50		m/s <sup>2</sup>
$d_A$	Creepage distance in air	11.2		mm
$a$	Max. allowable acceleration	9.7		mm

Data according to IEC 60747 and refer to a single diode unless otherwise stated.  
 ① for resistive load at bridge output.

IXYS reserves the right to change limits, test conditions and dimensions.

© IXYS All rights reserved

Dimensions in mm (1 mm = 0.0394")

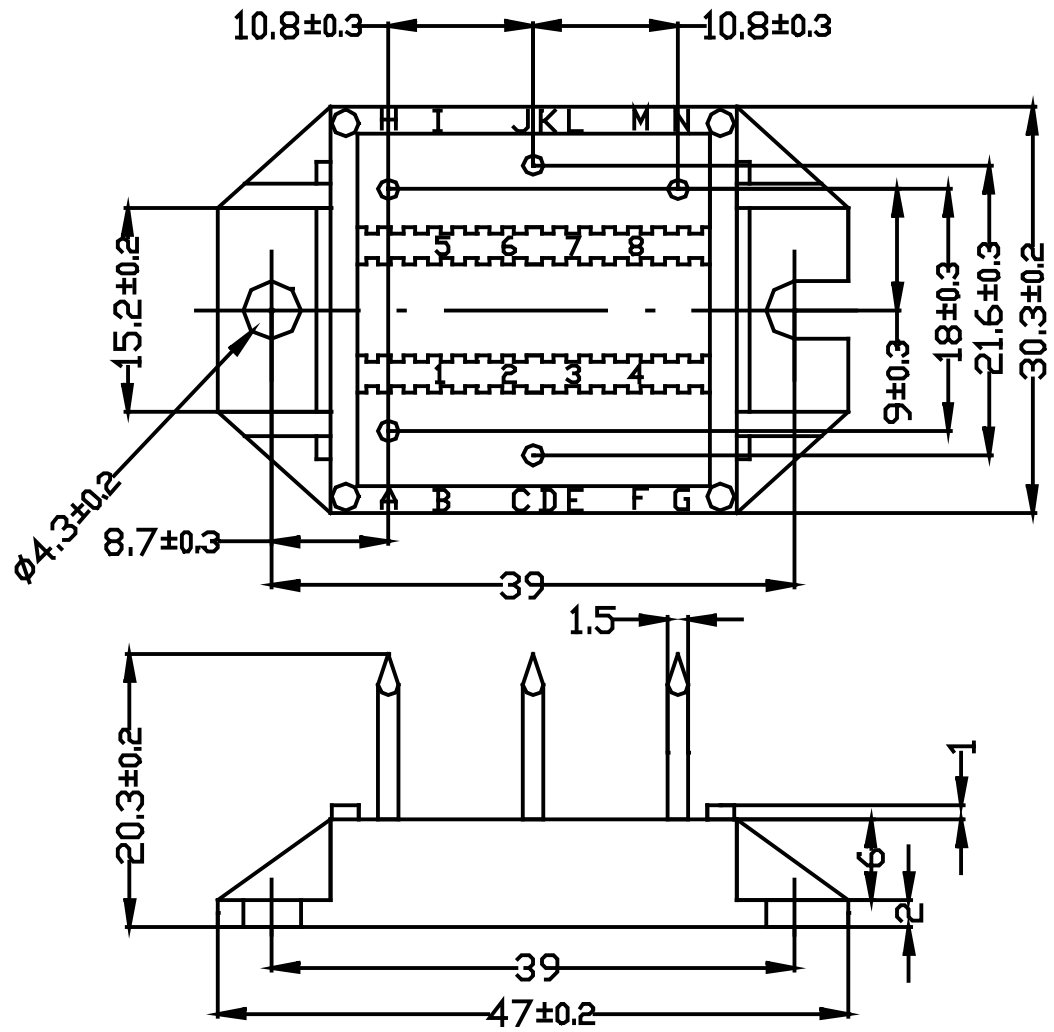

IXYS reserves the right to change limits, test conditions and dimensions.

© IXYS All rights reserved

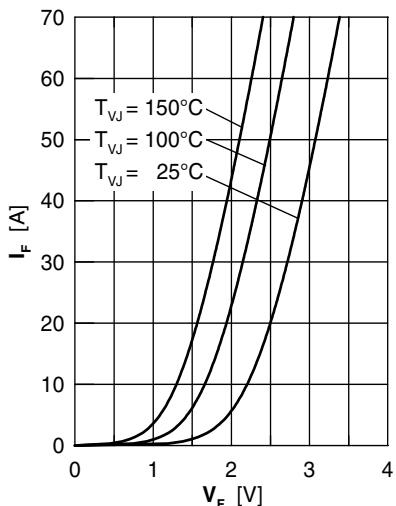

Fig. 1 Forward current  $I_F$  vs.  $V_F$

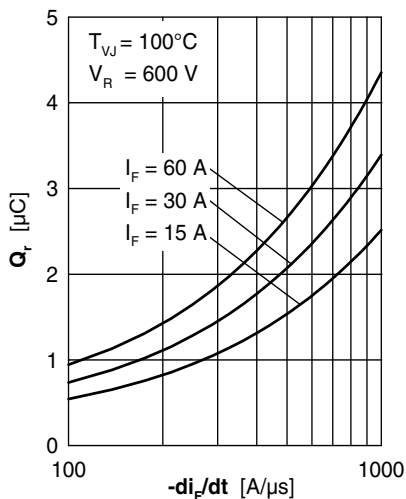

Fig. 2 Reverse recovery charge  $Q_r$  versus  $-di_F/dt$

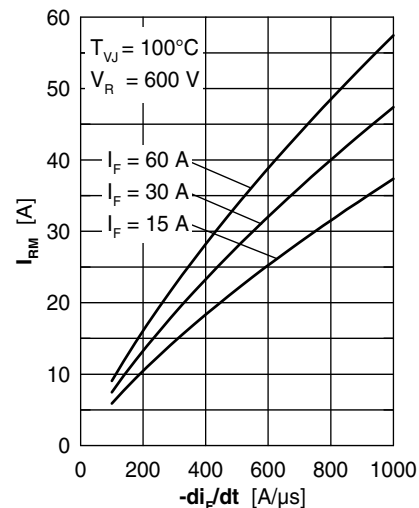

Fig. 3 Peak reverse current  $I_{FRM}$  versus  $-di_F/dt$

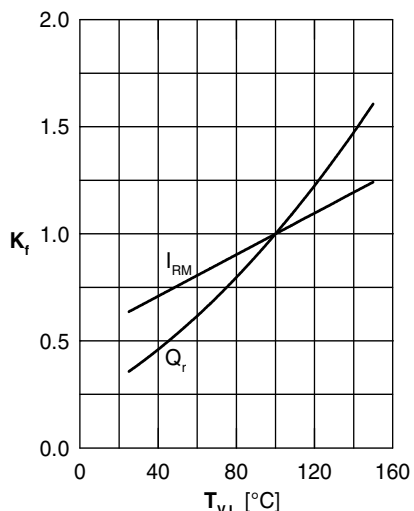

Fig. 4 Dynamic parameters  $Q_r$ ,  $I_{FRM}$  versus  $T_{VJ}$

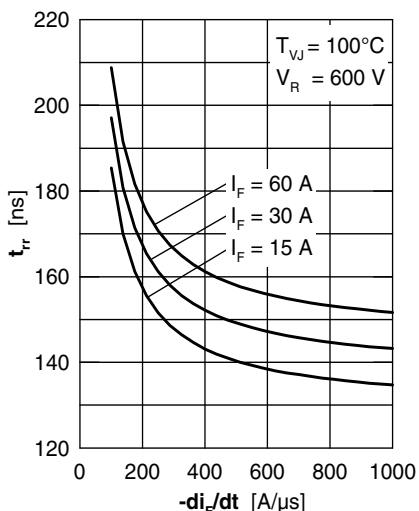

Fig. 5 Recovery time  $t_{tr}$  vs.  $-di_F/dt$

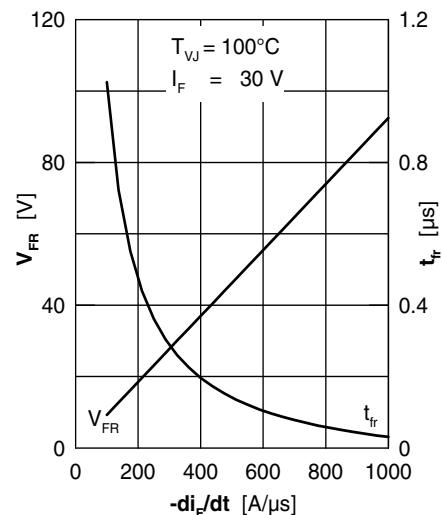

Fig. 6 Peak forward voltage  $V_{FR}$  and  $t_{tr}$  versus  $di_F/dt$

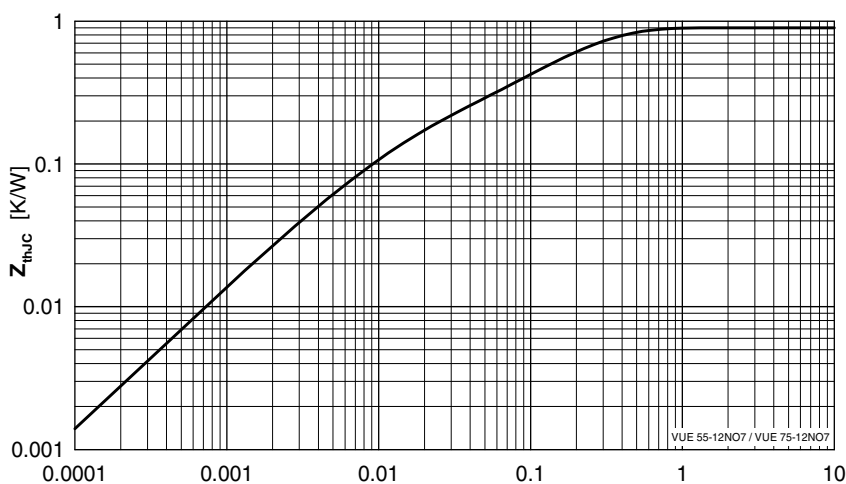

Fig. 7 Transient thermal resistance junction to case

Constants for  $Z_{thjC}$  calculation:

i	$R_{thi}$ (K/W)	$t_i$ (s)
1	0.3012	0.0052
2	0.116	0.0003
3	0.0241	0.0004
4	0.4586	0.0092